

# YAMAHA KP-300

*Digital Karaoke Processor*

---

OWNER'S MANUAL

# SAFETY INSTRUCTIONS



## • Explanation of Graphical Symbols

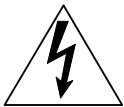

The lightning flash with arrowhead symbol, within an equilateral triangle, is intended to alert you to the presence of uninsulated "dangerous voltage" within the product's enclosure that may be of sufficient magnitude to constitute a risk of electric shock to persons.



The exclamation point within an equilateral triangle is intended to alert you to the presence of important operating and maintenance (servicing) instructions in the literature accompanying the appliance.

## WARNING

To reduce the risk of fire or electric shock, do not expose this unit to rain or moisture.

- 1 Read Instructions – All the safety and operating instructions should be read before the appliance is operated.
- 2 Retain Instructions – The safety and operating instructions should be retained for future reference.
- 3 Heed Warnings – All warnings on the appliance and in the operating instructions should be adhered to.
- 4 Follow Instructions – All operating and use instructions should be followed.
- 5 Attachments – Do not use attachments not recommended by the video product manufacturer as they may cause hazards.
- 6 Water and Moisture – Do not use this unit near water – for example, near a bath tub, wash bowl, kitchen sink, or laundry tub, in a wet basement, or near a swimming pool, and the like.
- 7 Carts and Stands – The appliance should be used only with a cart or stand that is recommended by the manufacturer.
- 7A An appliance and cart combination should be moved with care. Quick stops, excessive force, and uneven surfaces may cause the appliance and cart combination to overturn.
- 8 Ventilation – The appliance should be situated so that its location or position does not interfere with its proper ventilation. For example, the appliance should not be situated on a bed, sofa, rug, or similar surface that may block the ventilation openings; or, placed in a built-in installation, such as a bookcase or cabinet that may impede the flow of air through the ventilation openings.
- 9 Heat – The appliance should be situated away from heat sources such as radiators, heat registers, stoves, or other appliances (including amplifiers) that produce heat.
- 10 Power Sources – The appliance should be connected to a power supply only of the type described in the operating instructions or as marked on the appliance.
- 11 Grounding or Polarization – Precautions should be taken so that the grounding or polarization means of an appliance is not defeated.
- 12 Power-Cord Protection – Power-supply cords should be routed so that they are not likely to be walked on or pinched by items placed upon or against them, paying particular attention to cords at plugs, convenience receptacles, and the point where they exit from the appliance.
- 13 Cleaning – Unplug this unit from the wall outlet before cleaning. Do not use liquid cleaners or aerosol cleaners. Use a damp cloth for cleaning.
- 14 Power Lines – An outdoor antenna should be located away from power lines.
- 15 Nonuse Periods – The power cord of the appliance should be unplugged from the outlet when left unused for a long period of time.
- 16 Object and Liquid Entry – Care should be taken so that objects do not fall and liquids are not spilled into the enclosure through openings.
- 17 Damage Requiring Service – The appliance should be serviced by qualified service personnel when:
  - A. The power-supply cord or plug has been damaged; or
  - B. Objects have fallen into the appliance; or
  - C. The appliance has been exposed to rain; or
  - D. The appliance does not appear to operate normally or exhibits a marked change in performance; or
  - E. The appliance has been dropped, or the enclosure damaged.
- 18 Servicing – The user should not attempt to service the appliance beyond that described in the operating instructions. All other servicing should be referred to qualified service personnel.

## CAUTION

The apparatus is not disconnected from the AC power source so long as it is connected to the wall outlet, even if the apparatus itself is turned off.

## Note to CATV system installer (U.S.A.):

This reminder is provided to call the CATV system installer's attention to Article 820-40 of the NEC that provides guidelines for proper grounding and, in particular, specifies that the cable ground shall be connected to the grounding system of the building, as close to the point of cable entry as practical.

## FCC INFORMATION (U.S.A.)

### 1. IMPORTANT NOTICE: DO NOT MODIFY THIS UNIT!

This product, when installed as indicated in the instructions contained in this manual, meets FCC requirements. Modifications not expressly approved by Yamaha may void your authority, granted by the FCC, to use the product.

### 2. IMPORTANT:

When connecting this product to accessories and/or another product use only high quality shielded cables. Cable/s supplied with this product MUST be used. Follow all installation instructions. Failure to follow instructions could void your FCC authorization to use this product in the USA.

### 3. NOTE:

This product has been tested and found to comply with the requirements listed in FCC Regulations, Part 15 for Class "B" digital devices. Compliance with these requirements provides a reasonable level of assurance that your use of this product in a residential environment will not result in harmful interference with other electronic devices. This equipment generates/uses radio frequencies and, if not installed and used according to the instructions found in the owner's manual, may cause interference harmful to the operation of other electronic devices. Compliance with FCC regulations does not guarantee that interference will not occur in all installations. If this product is found to be the source of interference, which can be determined by turning the unit "OFF" and "ON", please try to eliminate the problem by using one of the following measures:

Relocate either this product or the device that is being affected by the interference.

Use power outlets that are on different branch (circuit breaker or fuse) circuits or install AC line filter/s.

In the case of radio or TV interference, relocate/reorient the antenna. If the antenna lead-in is 300 ohm ribbon lead, change the lead-in to coaxial type cable.

If these corrective measures do not produce satisfactory results, please contact your local retailer authorized to distribute this type of product. If you can not locate the appropriate retailer, please contact Yamaha Electronics Corp., U.S.A. 6600 Orangethorpe Ave., Buena Park, CA90620.

## We Want You Listening For A Lifetime

YAMAHA and the Electronic Industries Association's Consumer Electronics Group want you to get the most out of your equipment by playing it at a safe level. One that lets the sound come through loud and clear without annoying blaring or distortion – and, most importantly, without affecting your sensitive hearing. Since hearing damage from loud sounds is often undetectable until it is too late, YAMAHA and the Electronic Industries Association's Consumer Electronics Group recommend you avoid prolonged exposure to excessive volume levels.



## CAUTION: READ THIS BEFORE OPERATING YOUR UNIT

- 1 To ensure the finest performance, please read this manual carefully. Keep it in a safe place for future reference.
- 2 Install your unit in a cool, dry, clean place – away from windows, heat sources, and too much vibration, dust, moisture or cold. Avoid sources of hum (transformers, motors). To prevent fire or electrical shock, do not expose to rain and water.
- 3 Do not operate the unit upside-down.
- 4 Never open the cabinet. If a foreign object drops into the set, contact your dealer.
- 5 Place the unit in a location with adequate air circulation. Do not interfere with its proper ventilation; this will cause the internal temperature to rise and may result in a failure.
- 6 Do not use force on switches, knobs or cords. When moving the set, first turn the unit off. Then gently disconnect the power plug and the cords connecting to other equipment. Never pull the cord itself.
- 7 Do not attempt to clean the unit with chemical solvents: this might damage the finish. Use a clean, dry cloth.
- 8 Be sure to read the "Troubleshooting" section on common operating errors before concluding that your unit is faulty.
- 9 This unit consumes a fair amount of power even when the power switch is turned off. We recommend that you unplug the power cord from the wall outlet if the unit is not going to be used for a long time. This will save electricity and help prevent fire hazards. To disconnect the cord, pull it out by grasping the plug. Never pull the cord itself.
- 10 To prevent lightning damage, pull out the power cord and remove the antenna cable during an electrical storm.
- 11 The general digital signals may interfere with other equipment such as tuners or receivers. Move the system farther away from such equipment if interference is observed.

### NOTE:

Please check the copyright laws in your country before recording from records, compact discs, radio, etc. Recording of copyrighted material may infringe copyright laws.

### Voltage Selector (General Model only)

Be sure to position the voltage selector to match the voltage of your local power lines before installing the unit.

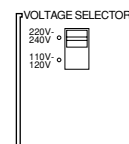

# CONTENTS

FEATURES .....	4
CONNECTIONS .....	5
BASIC OPERATION .....	5
KARAOKE EFFECTS AND FUNCTIONS .....	6
TROUBLESHOOTING .....	Back cover
SPECIFICATIONS .....	Back cover

# FEATURES

- Four audio and two video inputs (AUX, TAPE, LD/CDG, and VCR) let you connect various audio and video components.
- ECHO control lets you add an echo effect to the voices coming through the microphones.
- DIGITAL KEY CONTROL lets you select the musical pitch you desire ( $\pm 3$  notes in 13 positions).
- MAGIC VOCAL lets you adjust the sound of your singing voice by up to  $\pm 1$  octave in 15 positions to provide a variety of fun possibilities.
- MPX BAL control lets you adjust the volume of original vocals when using Sound Multiplex sources.
- One Touch Karaoke reduces the level of original vocals in stereo sources so that they can be used as karaoke sources.
- Vocal Aid fills in the parts you don't sing with the original vocals.
- Four different built-in Digital Super Surround (DSS) settings: Ballad, Pops, Jazz, and Rock, let you obtain vocal effects suitable for the type of music you are playing.
- You can record karaoke performances on a cassette deck and/or VCR connected to this unit.

## **Reproducing karaoke sources with this unit**

Sound Multiplex tapes or discs designed for karaoke use (i.e., laser karaoke), generally have background music and original vocals on the right channel, but only background music on the left channel. When these sources are played back in Multiplex mode (refer to the manual supplied with your playback source for details), you can select the background music, or you can adjust the volume of the original vocals against that of the background music by rotating MPX BAL.

### **Note:**

There are some types of karaoke sources, with which the this unit's sound adjustments may not properly function. Please confirm the type of karaoke source you have purchased before attempting to reproducing it with this unit.

# CONNECTIONS

- Connect the power cords last.
- Be sure to disconnect the power cords of all audio and video components from their AC outlets before making connections. Do not turn the power on until all connections are complete.
- When making connections between this unit and other components, make sure that all connections are correct and you have connected L (left) to L and R (right) to R.

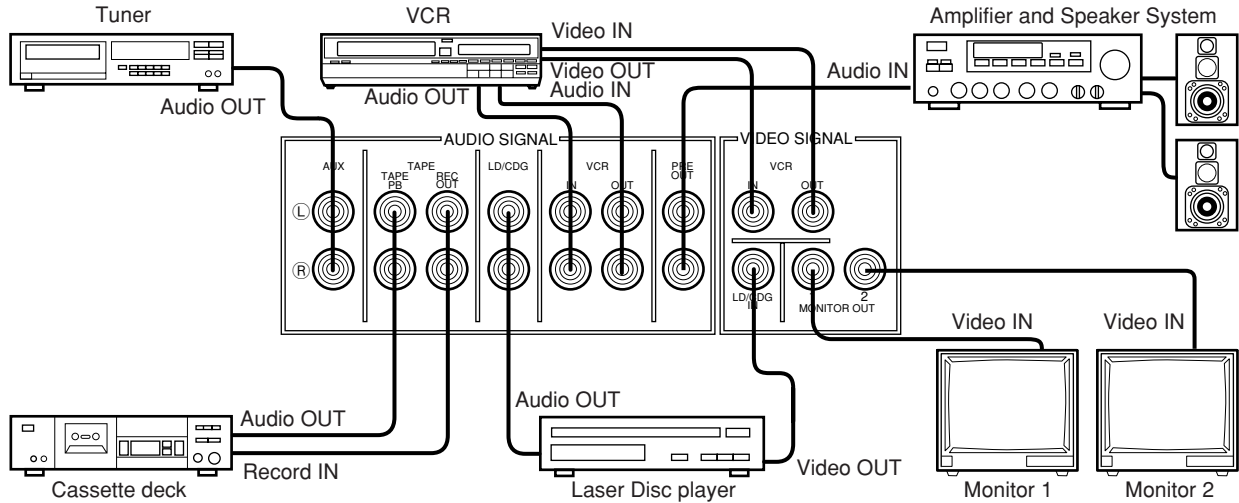

# BASIC OPERATION

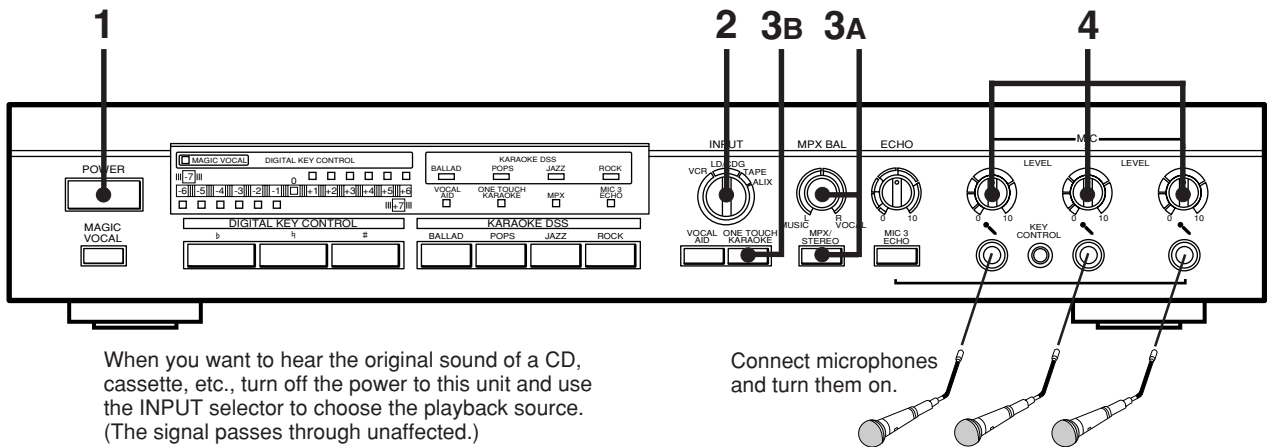

When you want to hear the original sound of a CD, cassette, etc., turn off the power to this unit and use the INPUT selector to choose the playback source. (The signal passes through unaffected.)

Connect microphones and turn them on.

**1** Turn on the power to this unit.

**2** Select the source to be played with the INPUT selector and start playback. Adjust the volume to an appropriate level.

**3A** When playing a Sound Multiplex source (Sound Multiplex karaoke discs or tapes, etc.)

**Press the MPX/STEREO button.** The MPX indicator lights.

**Adjust the MPX balance.**

To decrease the volume of the original vocals, turn toward "MUSIC".

**3B** When playing a stereo source (General CDs, LDs, or tapes, with vocals.)

**Set the MPX/STEREO button to STEREO.** The MPX indicator goes off.

**Press the ONE TOUCH KARAOKE button.**

The indicator lights, and the volume of the original vocals is reduced. (Original vocals may still be heard with some discs.)

**4** Adjust the microphone level(s) with the LEVEL control(s) while speaking into the microphone(s).

**5** Re-adjust the overall volume with the volume control on your amplifier.

# KARAOKE EFFECTS AND FUNCTIONS

Since magic vocal may produce unwanted effects during normal use, be sure the MAGIC VOCAL indicator is off when not in use.

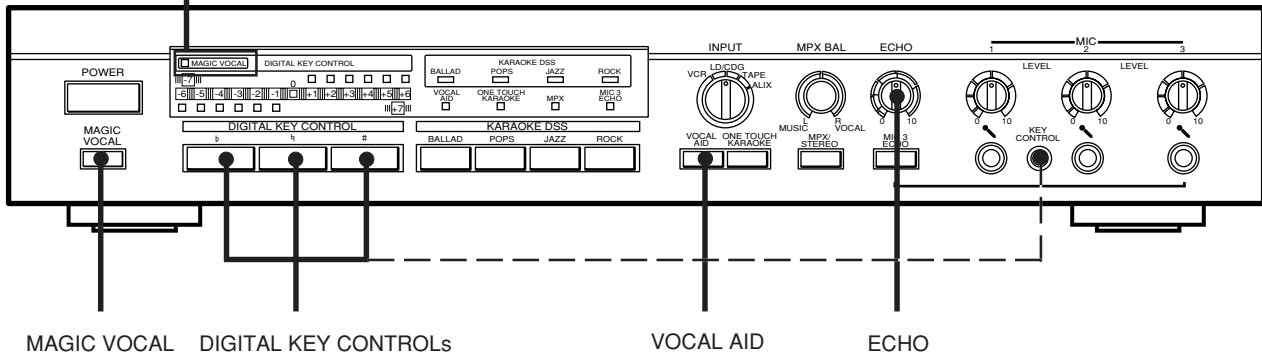

## Obtaining the desired musical pitch

Use the DIGITAL KEY CONTROL buttons to obtain the desired musical pitch ( $\pm 3$  notes, 13 positions). The DIGITAL KEY CONTROL indicators display the selected pitch.

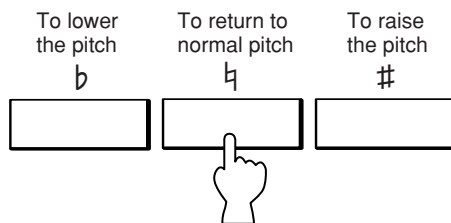

## Controlling the musical pitch with the microphone

You can also control the musical pitch with a YAMAHA microphone provided with a key control plug.

Connect the microphone to the MIC 1, 2, or 3 jack, and insert its key control plug into the KEY CONTROL jack.

## When you want to change your voice

Press the MAGIC VOCAL button to light the magic vocal indicator and you can use the DIGITAL KEY CONTROLS the same way you would change the musical pitch.

When the level is +7 or -7, the 5 and 6 indicators both light.



- You cannot use both the musical pitch control and the magic vocal function at the same time. Pressing MAGIC VOCAL turns off the musical pitch adjustments.
- The ECHO control does not work when magic vocal is on. Press the MAGIC VOCAL button to turn off the magic vocal function when not in use. Merely setting the level to "0" (neutral) does not turn off magic vocal.
- When you press MAGIC VOCAL, microphone output is cut for approximately 2 seconds to prevent speaker damage.

## Adding an echo effect to your voice

Use the ECHO control to adjust the echo effects for MICs 1, 2, and 3. Turn the ECHO control towards "10" to increase the echo level. Turn the control towards "0" to decrease it.

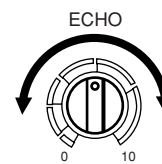

- The same echo effect is applied to MICs 1, 2, and 3.
- You can turn MIC 3's echo off and on separately from MICs 1 and 2 when you need a clear signal (for use by an MC, for example) by pressing MIC 3 ECHO.

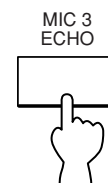

## Filling in with VOCAL AID

Press the VOCAL AID button to light the indicator. If you forget some lyrics, or stop singing in the middle of a song, the unit fills in with the original vocals.

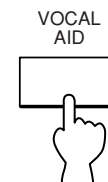

- When playing sound multiplex sources with the MPX/STEREO button set to MPX, use the MPX BALANCE control to adjust the volume of the original vocals.
- MAGIC VOCAL and VOCAL AID do not work with MIC 3 if the MIC 3 ECHO is turned off.

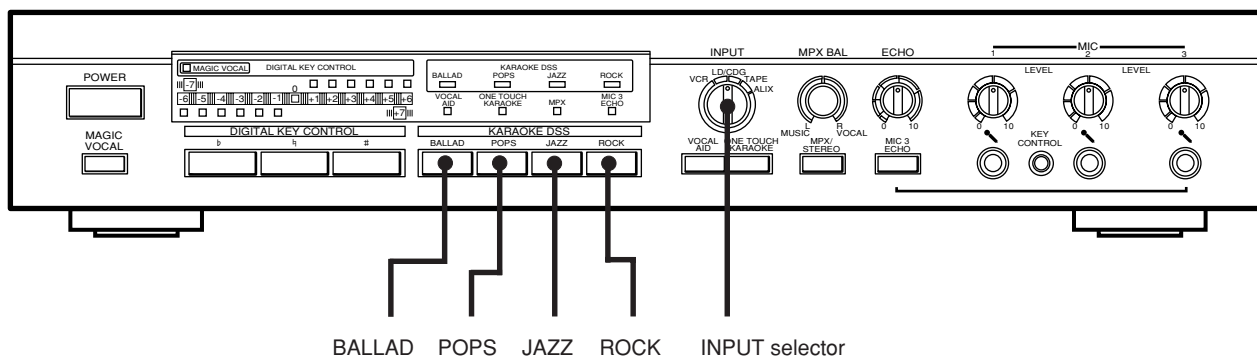

## Choosing vocal effects by music type

Press one of the following KARAOKE Digital Super Surround (DSS) buttons to select an effect appropriate for the type of music you are singing.

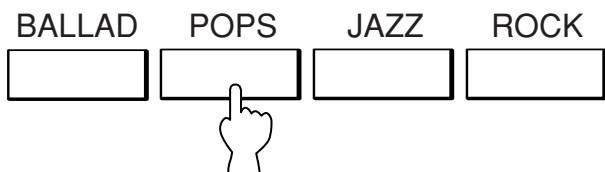

- BALLAD:** Suitable for mellow songs with slow-tempos; gives your voice and added sense of expression.
- POPS:** Suitable for pop music; provides a feeling of lightness.
- JAZZ:** Provides the reflections of a small hall, and creates an atmosphere similar to a jazz club.
- ROCK:** Suitable for rhythmical rock sounds; provides for dynamic vocals.

Press the same button again to cancel the effect.

- This function mostly effects sound coming through the microphone.

### If howling (a loud, high-pitched sound) occurs

Move the microphone farther away from the speakers, decrease the microphone level, or lower the overall volume with the volume control on your amplifier.

### Notes on the microphone

When a microphone is not being used, turn it off and unplug it.

## Recording karaoke

Karaoke can be recorded with a cassette deck and/or VCR connected to this unit. Before recording, select the source to be played with the INPUT selectors. When recording with the cassette deck, select a source other than TAPE, and select a source other than VCR for VCR recording.

### NOTES:

- During playback of a cassette deck connected to the TAPE PB jacks, that signal will not be output from the REC OUT jacks. Thus, you cannot record on cassette if the playback source is a cassette, even if separate cassette decks are connected to the TAPE PB jacks and REC OUT jacks. Also, it is not possible to record with a VCR connected to the VCR OUT jacks during playback from a VCR source connected to the VCR IN jacks.
- The settings for DIGITAL KEY CONTROL, KARAOKE, DSS, and ECHO are included in the recorded sound. Therefore, the recorded sound is similar to the sound output from the speakers.

## Including video output with audio sources

When you choose either TAPE or AUX with the INPUT selector, you can enjoy video images on the monitor from the LD/CDG component while listening to the sound from the TAPE or AUX component. If you set your VCR to the recording mode, you can record both the TAPE or AUX audio and LD/CDG video signals at the same time.

## TROUBLESHOOTING

If this unit fails to operate normally, check the following table. It lists common operating errors and simple measures which can correct them. If a problem cannot be corrected, or the symptom is not listed, disconnect the unit's power cord and contact your authorized YAMAHA dealer or service center for help.

SYMPTOM	POSSIBLE CAUSE	REMEDY
<b>Your voice is not heard through the microphone.</b>	Microphone plug is not firmly inserted into the jack.	Insert firmly.
	Microphone is turned off.	Turn on the power of the microphone.
<b>The volume of the original vocals cannot be reduced even when the MPX BAL control is turned to the MUSIC side.</b>	The MPX/STEREO button is not set properly.	<ul style="list-style-type: none"> <li>With sound multiplex sources, set the MPX/STEREO button to MPX. (The MPX indicator lights.)</li> <li>With general stereo sources, set the MPX/STEREO button to STEREO (the MPX indicator goes off) and press the ONE TOUCH KARAOKE button. The MPX BAL control does not function with these sources.</li> </ul>
<b>Your voice does not replace the original vocals when the VOCAL AID button is pressed.</b>	The volume level of the microphone is low.	Turn up the volume of the microphone with the MIC LEVEL control.
	The singing voice is not loud enough.	Sing louder.
<b>Sound from the playback source cannot be heard.</b>	The INPUT selector is not set properly.	Set it to the source to be played.
<b>The echo effect does not work</b>	MAGIC VOCAL is set to ON.	Turn off MAGIC VOCAL by pressing the MAGIC VOCAL button.

- Sometimes a failure (e.g., when buttons do not function) may be remedied by disconnecting the AC power cord from the wall outlet and connecting it again, since this resets the unit's microcomputer.

## SPECIFICATIONS

### Input Sensitivity/Impedance

MIC ..... 0.3 mV/32 k $\Omega$   
 LD, CD/CDG, AUX, TAPE, VCR ..... 150 mV/51 k $\Omega$

### Rated Output Level/Impedance

REC OUT ..... 150 mV/1.1 k $\Omega$   
 VCR OUT ..... 150 mV/1.1 k $\Omega$   
 PRE OUT ..... 150 mV/1.1 k $\Omega$

**Video Input Level/Impedance** ..... 1 V<sub>p-p</sub>/75  $\Omega$

**Video Output Level/Impedance** ..... 1 V<sub>p-p</sub>/75  $\Omega$

### Power Supply

General model ..... 110-120/220-240V, 50/60 Hz  
 Singapore model ..... 230V, 50 Hz  
 U.S.A. model ..... AC 120 V, 60 Hz

### Power Consumption

General model ..... 14 W  
 Singapore model ..... 13 W  
 U.S.A. model ..... 13 W

**Dimensions (W x H x D)** ..... 435 x 86 x 283 mm  
 (17-1/8 x 3-3/8 x 11-1/8 inch.)

**Weight** ..... 3.6 kg (7 lbs. 15 oz.)

### Accessories

Audio cord ..... 2  
 Video cord ..... 1

Specifications are subject to change without notice.

# YAMAHA

YAMAHA ELECTRONICS CORPORATION, USA 6660 ORANGETHORPE AVE., BUENA PARK, CALIF. 90620, U.S.A.

YAMAHA CANADA MUSIC LTD. 135 MILNER AVE., SCARBOROUGH, ONTARIO M1S 3R1, CANADA

YAMAHA ELECTRONIK EUROPA G.m.b.H. SIEMENSSTR. 22-34, 25462 RELINGEN BEI HAMBURG, F.R. OF GERMANY

YAMAHA ELECTRONIQUE FRANCE S.A. RUE AMBROISE CROIZAT BP70 CROISSY-BEAUBOURG 77312 MARNE-LA-VALEE CEDEX02, FRANCE

YAMAHA ELECTRONICS (UK) LTD. YAMAHA HOUSE, 200 RICKMANSWORTH ROAD WATFORD, HERTS WD1 7JS, ENGLAND

YAMAHA SCANDINAVIA A.B. J A WETTERGRENS GATA 1, BOX 30053, 400 43 VASTRA FRÖLUNDA, SWEDEN

YAMAHA MUSIC AUSTRALIA PTY, LTD. 17-33 MARKET ST., SOUTH MELBOURNE, 3205 VIC., AUSTRALIA

**YAMAHA CORPORATION**

VT30860 Printed in Malaysia